

(B)

(C)

(D)

(E)

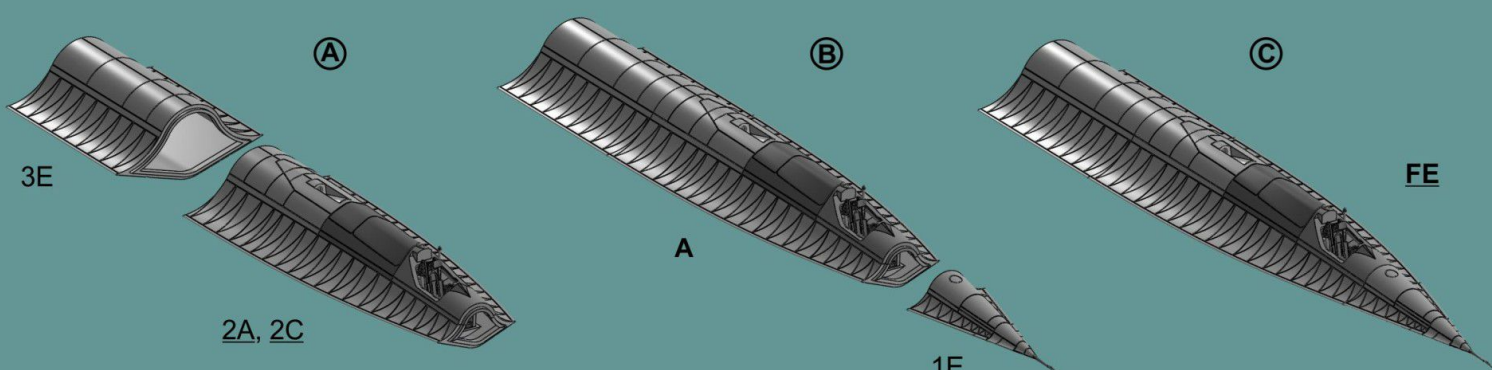
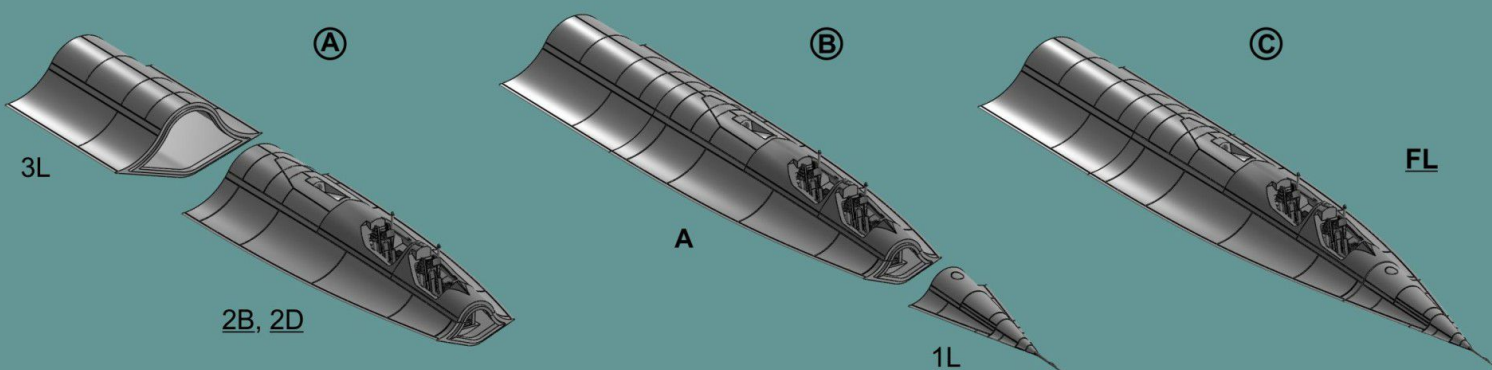
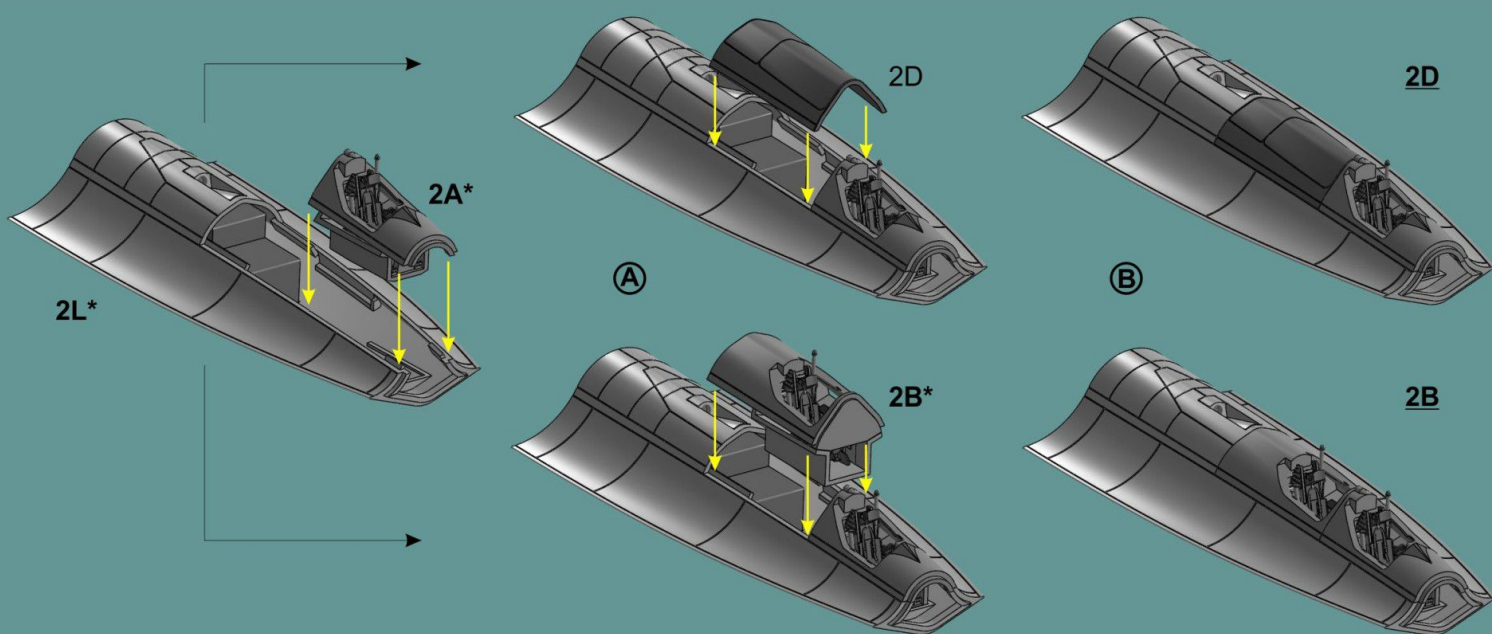
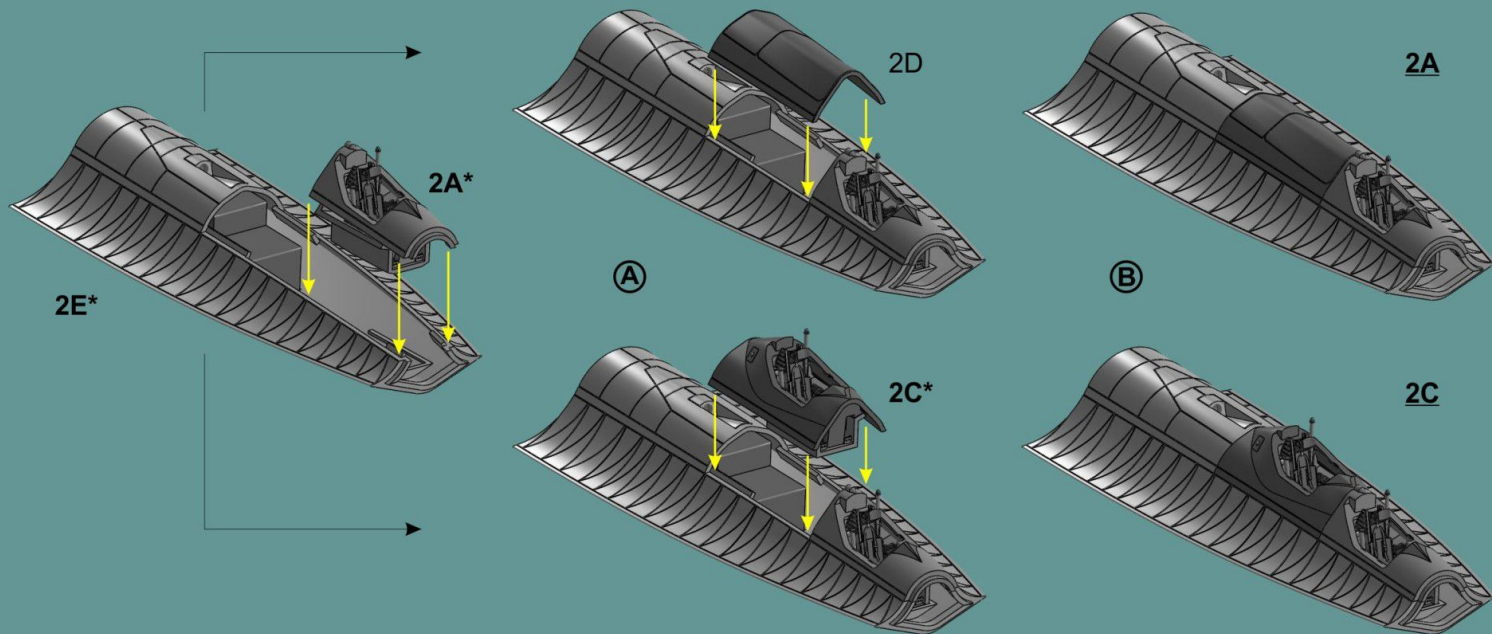

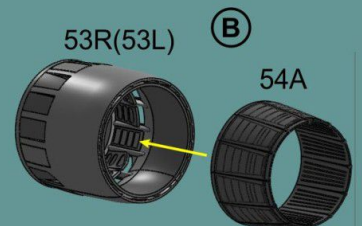
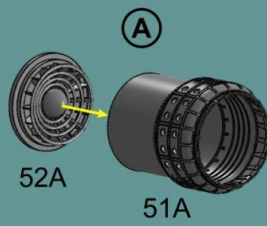
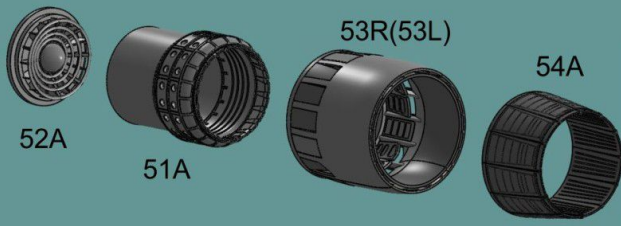

(Repeat the assembly for Left side)

